

Modeling of Processes in Subsurface Flow Constructed Wetlands: A Review

Günter Langergraber*

Constructed wetlands (CWs) provide a natural way for simple, inexpensive, and robust wastewater treatment. Detailed understanding of CW functioning is difficult, because a large number of physical, chemical, and biological processes occur in parallel and influence each other. For this reason, CWs have long been seen as “black boxes” where wastewater enters and treated water leaves the system. Numerical models describing the biochemical transformation and degradation processes in CWs are promising tools to better understand CW functioning. The first part of this paper reviews published mechanistic models for CWs. Horizontal flow systems can be simulated when only water flow saturated conditions are considered; six models have been reviewed whereby a series or network of completely stirred tank reactors is most frequently used to describe the hydraulics. For modeling vertical flow CWs with intermittent loading, transient variably saturated flow models are required. Due to the intermittent loading, these systems are highly dynamic, adding to the complexity of the overall system. Five models of different complexity have been reviewed; three use the Richards equation to describe variably saturated flow, whereas the two others use simplified approaches. In the second part of the paper, the multicomponent reactive transport module CW2D is demonstrated. Simulation results for CWs treating domestic wastewater, combined sewer overflow, and surface water are presented. In general, a good match between simulation results and measured data could be achieved if the hydraulic behavior of the system could be described well. Based on the experience from these examples, the need for further model development is determined.

ABBREVIATIONS: AO7, acid orange 7; ASM, Activated Sludge Model; BOD, biochemical oxygen demand; COD, chemical oxygen demand; CSO, combined sewer overflow; CSTR, completely stirred tank reactor; CW, constructed wetland; HF, horizontal flow; HRT, hydraulic residence time; PSCW, pilot-scale constructed wetland; RCB, RetrasoCodeBright; RTD, residence time distribution; SF, surface flow; SIR, substrate-induced respiration; SSF, subsurface flow; VF, vertical flow.

DESPITE CONSIDERABLE experience constructing and operating CWs, these systems are still often considered figurative black boxes in which water is treated. Until now, CW design has been mainly based on rule of thumb approaches using specific surface area requirements (e.g., Brix and Johansen, 2004; ÖNORM B 2505, 2005; DWA-A 262, 2006) or simple first-order decay models (e.g., Kadlec and Knight, 1996; Rousseau et al., 2004). However, Kadlec (2000) documents that first-order models are inadequate for the design of treatment wetlands.

Constructed wetlands are engineered to optimize the treatment conditions found in natural wetlands by using a complex mixture of water, substrate, plants, litter (fallen plant material), and a variety of microorganisms (especially bacteria). The large number of physical, chemical, and biological processes operating simultaneously and influencing each other makes the CW system difficult to understand. Numerical models have drawn increased attention in recent years because they can provide insight into

the black box and therefore improve our understanding of the system. Once reliable numerical models exist, they can be used to evaluate and improve the existing design criteria.

Wetland treatment systems effectively treat organic matter and pathogens. Water plants (macrophytes) have several relevant properties, the most important being their physical effects (Brix, 1997; Kadlec et al., 2000). The amount of nutrients removed by plant harvesting is generally insignificant compared to yearly loadings with wastewater. If plants are not harvested, the nutrients will be returned to the water during plant decomposition (Brix, 1997; Tanner, 2001). Applications of CWs include treatment of domestic, agricultural, and industrial wastewater; storm water; and landfill leachate. In general, the use of CWs provides a relatively simple, inexpensive, and robust solution for treatment. As natural treatment systems, CWs require a larger specific surface area compared to technical solutions such as activated sludge. However, CWs usually have lower operation and maintenance expenses and other additional benefits, including tolerance against fluctuations of flow and pollution load, ease of water reuse and recycling, provision of habitat for many wetland organisms, and a more aesthetic appearance than technical treatment options (Kadlec et al., 2000; Haberl et al., 2003).

Constructed wetlands can be subdivided into two main types: surface flow (SF) and subsurface flow (SSF) CWs (Kadlec and Knight, 1996; Haberl et al., 2003). Surface flow, or free water surface CWs, are densely vegetated and have typical water depths of less than 0.4 m. Subsurface flow CWs, which have no visible free water, are subdivided into horizontal flow (HF) and vertical flow (VF) systems depending on the direction of water flow through

Institute of Sanitary Engineering and Water Pollution Control, Univ. of Natural Resources and Applied Life Sciences, Vienna (BOKU), Muthgasse 18, A-1190 Vienna, Austria. Received 22 Mar. 2007. *Corresponding author (gunter.langergraber@boku.ac.at).

Vadose Zone J. 7:830–842
doi:10.2136/vzj2007.0054

© Soil Science Society of America
677 S. Segoe Rd. Madison, WI 53711 USA.
All rights reserved. No part of this periodical may be reproduced or transmitted in any form or by any means, electronic or mechanical, including photocopying, recording, or any information storage and retrieval system, without permission in writing from the publisher.

the porous medium (sand or gravel). To prevent clogging of the porous filter material, the use of traditional SSF CWs is limited to mechanically pretreated wastewater, which contains less particulate content. Compared to SF systems, the contact area of water with bacteria and substrate is much larger, decreasing the area requirement for SSF CWs (Vymazal et al., 1998).

In an HF CW (Fig. 1), water enters the inlet and flows slowly under the surface through the porous media until it reaches the outlet zone, where it is collected and discharged. Oxygen for aerobic processes is obtained mainly via diffusion from the atmosphere. The amount of oxygen transported from the roots into zones under the water table is still under discussion; however, it is too little to facilitate aerobic processes. Therefore, anoxic and anaerobic processes play the most important role in HF CWs. Organic matter is decomposed both aerobically and anaerobically, resulting in efficient removal. Insufficient oxygen supplies results in incomplete nitrification (Langergraber and Haberl, 2001).

Vertical flow CWs with intermittent loading are widely used today because they efficiently remove ammonia nitrogen. Figure 2 shows the typical setup of a VF CW. Water is loaded intermittently, and the large amount of water from a single loading causes flooding of the surface. The water infiltrates into the substrate, then gradually drains down vertically and is collected by a drainage network at the base. Air re-enters the system until the next loading, and great oxygen transfer rates into the system are possible. Vertical flow CWs with intermittent loading are therefore suitable when nitrification and other strictly aerobic processes are required (Langergraber and Haberl, 2001, Kayser and Kunst, 2005). In the last decade, VF CWs for treating raw wastewater have also been introduced and successfully applied (e.g., Molle et al., 2005).

Few numerical models are available to describe treatment processes in SSF CWs. Much of the literature on models for CWs (mostly HF CWs) refers to simple first-order decay models (e.g., Pastor et al., 2003; Stein et al., 2006; Tomenko et al., 2007) where only effluent concentrations are predicted based on influent concentrations. Pastor et al. (2003) used hybrid neural network models to model the rate constant of the first-order decay model to predict effluent concentrations of HF CWs with the goal of optimizing their design. Using a similar approach, Tomenko et al. (2007) compared the accuracy and efficiency of multiple

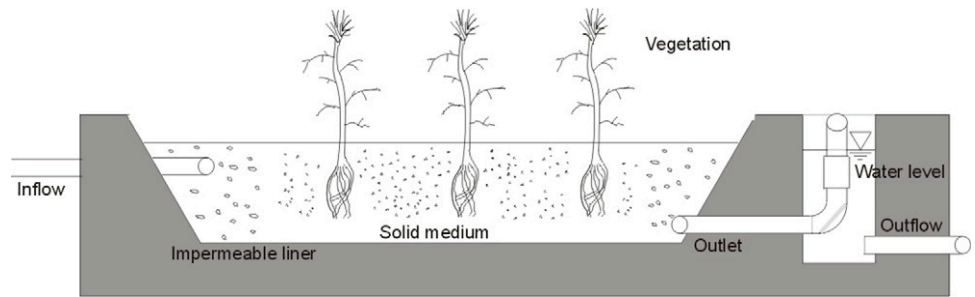

FIG. 1. Longitudinal cross-section of a horizontal flow constructed wetland (Langergraber and Haberl, 2004).

regression analysis and artificial neural networks when used to predict biochemical oxygen demand (BOD) effluent concentrations of HF CWs. Stein et al. (2006) estimated the temperature dependence of the model parameters of the $k-C^*$ first-order degradation model proposed by Kadlec and Knight (1996) for chemical oxygen demand (COD) removal in a batch-fed CW system using four plant species. Rousseau et al. (2004) compared different design models for HF CWs and demonstrated the output variability of these models. The $k-C^*$ first-order degradation model has been shown to be the most suitable for design purposes. However, the authors claimed that this suitability is only true when model parameters from systems operating under similar conditions (i.e., climatic conditions, wastewater composition, porous filter material, and plant species) are available.

This review article considers only mechanistic models. The first section presents the available models in three different categories: (i) models describing hydraulic behavior and single-solute transport only; (ii) models describing reactive transport in saturated conditions, such as in HF CWs; and (iii) reactive transport models for variably saturated conditions, the most complex models which are used to model both VF and HF CWs. The second part of the article demonstrates the multicomponent reactive transport module CW2D (Langergraber, 2001; Langergraber and Šimůnek, 2005) and provides examples of its application.

Review of Mechanistic Models for Subsurface Flow Constructed Wetlands

Models Describing the Hydraulic Behavior and Single-Solute Transport in Constructed Wetlands

Several authors have conducted tracer experiments to evaluate the hydraulic behavior of SSF CWs. Tracer experiments are also used to calibrate the hydraulic behavior of the system, including the more complex models described in the next sections.

Werner and Kadlec (2000) modeled the nonideal flow of CWs with a network of an infinite number of small stirred tanks distributed along a set of main plug flow channels. Although the method has been developed mainly for SF wetlands, it can also be applied to subsurface HF CWs. The basic concept of the model assumes that the CW has an infinite number of microzones of diminished mixing along a set of main channels. These zones are not excluded "dead zones," but they only exchange water with the main flows on a limited basis. In total, 47 tracer studies from

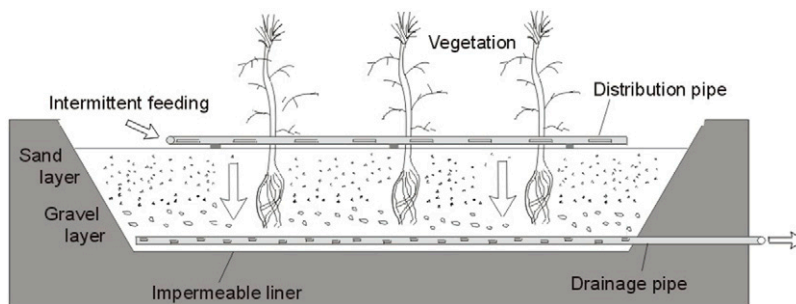

FIG. 2. Typical setup of a vertical flow constructed wetland (Langergraber and Haberl, 2004).

four different sites were investigated. The model was capable of producing realistic wetland residence time distributions (RTDs), and reproduced the experimental RTDs from impulse tracer studies performed on both steady and variable flow systems for the more reliable and carefully performed experiments. The authors concluded that their method was more flexible than tanks-in-series models and could therefore better reproduce the different anomalies observed at the four sites.

Chazarenc et al. (2003) applied mathematical tools from chemical engineering to model the hydraulic residence time (HRT) distribution of a HF CW in France. The nonideal flow wetland was modeled by dispersion plug flow and stirred-tanks-in-series models. Six experimental HRTs were monitored and modeled. In dry periods, significant dispersion occurred; in wet periods, plug flow behavior could be observed. Results from dispersion plug flow and stirred-tanks-in-series models showed that evapotranspiration played a major role in summer HRT simulations. Evapotranspiration seemed to reduce dispersion. It was shown that the design of the system was favorable for developing preferential flow paths, which also gave rise to dead and stagnant zones. Additionally, short cut flows occurred due to surface flow during periods of heavy rain. The conceptual models developed could fit all response curves.

García et al. (2004) modeled tracer tests performed at pilot HF CWs with different filter materials and different length/width ratios of 1:1, 1.5:1, and 2:1. Nonideal flow models (plug flow with dispersion and completely stirred tank reactors (CSTRs) in series with delay) have been applied. The CSTRs-in-series-with-delay model represented the data more accurately when compared with the plug flow with dispersion model. García et al. (2004) concluded that the former fits the asymmetry of the tracer response more accurately. The number of CSTRs required ranged from one to three. The main conclusion of their study was that the construction of a HF CW with a higher length/width ratio and finer medium improves the hydraulic behavior of the system and reduces internal dispersion.

Małoszewski et al. (2006) used tracer experiments to determine hydraulic parameters in three parallel inhomogeneous gravel beds at an HF CW in Poland. Instantaneously injected bromide and tritium tracers were used to obtain RTDs. The multifold dispersion model assumed the existence of several flowpaths with different hydraulic properties; it was developed using the respective parallel combination of analytical solutions from the one-dimensional advection–dispersion equation. The model was successfully used to fit the experimental tracer breakthrough curves, to identify the different flow components, and to derive wastewater volumes, water-saturated porosity, mean wastewater travel times, longitudinal dispersivities, and hydraulic conductivity from model parameters. The application of the model, which describes possible diffusion of tracer into the zones with stagnant water, has demonstrated that the calibration of such a model is possible. However, the diffusion properties of the tracer obtained from the model parameters were unrealistic, which suggested that the zones with stagnant water played an insignificant role in the investigated system.

Schwager and Boller (1997) simulated tracer experiments and oxygen transport in intermittent sand filters using an older version of HYDRUS-1D (Šimůnek et al., 1998) and MOFAT (Katyal et al., 1991), respectively. However, Schwager and Boller

(1997) did not consider reactive transport. The effect of biomass accumulation on solute breakthrough was assessed experimentally by tracer studies. HYDRUS was used to extrapolate to different hydraulic conditions. MOFAT was used simultaneously to include the effects of water and air flow. The simulations have been used to estimate oxygen fluxes by advection and diffusion into the top 10 cm of the filter. At a hydraulic loading rate of $120 \text{ L m}^{-2} \text{ d}^{-1}$, the oxygen flux was found to be 9 and $30 \text{ mg O}_2 \text{ m}^{-2} \text{ min}^{-1}$ caused by advection and diffusion, respectively. The calculated results could be confirmed by gas tracer experiments. The results strengthened the assumption that oxygen mainly enters the pores in the intervals between intermittent loadings via diffusion.

Reactive Transport Models for Saturated Conditions

To simulate HF CWs, several authors have been coupling reactive transport models and ideal reactor models such as a series of CSTRs and/or plug flow reactors, respectively. In these reactors, either first-order decay rates or Monod kinetics are applied to model the degradation processes for organic matter and/or nitrogen.

Chen et al. (1999) used the mixing cell method to model the BOD elimination process. The HF bed is subdivided into a number of same-sized cells that are assumed to be completely mixed. In each cell, the degradation is described by a first-order rate constant. By using this approach, it is possible to derive an analytical solution for the effluent BOD concentration as a function of the number of cells. The model is a simplification of the advection–dispersion partial differential equation. The dispersion coefficient, the length, and the flow rate of the HF bed determined the number of cells required to get good results. The applications of the model presented by Chen et al. (1999) indicate that the model is able to produce a better match to measured data than a plug flow model and can be also applied to transient conditions such as variable flow rates.

A mechanistic, compartmental simulation model was developed by Wynn and Liehr (2001) to model and predict seasonal trends in the removal efficiencies of HF CWs. The model consists of six linked submodels representing the carbon cycle, the nitrogen cycle, an oxygen balance, autotrophic bacteria growth, heterotrophic bacteria growth, and a water budget. Bacterial growth rates are modeled using Monod-type reaction kinetics. The carbon cycle considers several state variables, including plant biomass, dissolved and particulate organic carbon, and refractory carbon. The wetland is assumed to act as either a single CSTR or a series of CSTRs. Data from an existing CW were used to calibrate the model. In general, the model predicts effluent BOD, organic nitrogen, ammonium, and nitrate concentrations well. The model also reproduces seasonal trends well. Interactions between the carbon, nitrogen, and oxygen cycles were evident in model outputs. Because little was known about the root zone aeration by wetland plants, oxygen predictions were fair. The model was generally insensitive to changes in individual parameters, assumably because of the complexity of both the ecosystem and the model, as well as the numerous feedback mechanisms. The model was most sensitive to changes in parameters that affect microbial growth and substrate use directly. Wynn and Liehr (2001) concluded that, with further evaluation and refinement, the model could be a useful design tool for HF CWs. However, no further work has been published since 2001.

Mashauri and Kayombo (2002) developed a coupled model for a waste stabilization pond and HF CW based on the growth rate kinetics described by Monod kinetic equations. The transformation of organic carbon considered heterotrophic growth and die-off of bacteria, and mineralization and settling of organic matter. The main goal of the modeling exercise was to verify how much of the influent organic carbon is degraded, used for biomass growth, and settled. No description of the hydraulic model was given, but it can be assumed that the model is only capable of dealing with constant flow rates. Mashauri and Kayombo (2002) concluded that the processes in the pond and CW system may well be defined by the Monod approach on substrate utilization and growth. The transformation of organic carbon was found to be dominated by mineralization, which led to high growth of heterotrophic bacteria in the systems. This was also shown by the amount of organic carbon that accumulated in the system. The model also revealed and quantified the amount of algae growing on utilization of carbon dioxide produced by oxidation processes in the pond.

The model presented by Mayo and Bigambo (2005) was developed to predict nitrogen transformation in HF CWs. The mathematical model considers the activities of biomass suspended in the water body and biofilm on aggregates and plant roots. The state variables modeled include organic, ammonia, and nitrate nitrogen, which were sequestered in water, plants, and aggregates. The nitrogen transformation processes considered are mineralization, nitrification, denitrification, plant uptake, release after plant decay, and sedimentation. Environmental conditions considered are temperature, pH, and dissolved oxygen. The experimental CWs used for calibration and validation of the model operated with constant water flow, as the model was designed only for constant flow rates. A total nitrogen removal of 48.9% was achieved, with denitrification (29.9%), plant uptake (10.2%), and net sedimentation (8.2%) as the major pathways. In a further study, Bigambo and Mayo (2005) investigated the significance of the biofilm biomass in nitrogen removal. The amount of biomass present had no influence on the removal of organic nitrogen; however, it significantly influenced ammonia nitrogen and nitrate nitrogen transformation. The developed CW model was also coupled with a high rate pond (Mayo and Mutamba, 2005).

Marsili-Libelli and Checchi (2005) proposed the combination of a set of ideal reactors with a robust identification method to approximate the dispersed flow and pollution reduction dynamics in HF CWs. The models are based on combinations of series and parallel CSTRs of unequal volumes in series with a plug flow reactor. In each reactor, carbon removal is modeled using either first-order or Monod kinetics. The motivation for such a simple model was to avoid the difficulties in estimating the large number of input parameters required by other models. The estimation technique computes the parameter's confidence regions on the basis of two differing approximations producing coincident regions only in the case of a consistent identification and thus allows structural discrimination on the basis of the agreement of these regions. This test has been shown to be very sensitive to structural and parametric perturbations and can detect model criticality not revealed by other performance indexes. Different model structures have been calibrated with data sets from several CWs with widely differing hydraulics and pollution removal characteristics, drawn either from the literature or from field experiments performed by the authors. The identification method can assist in the selection of the best com-

ination of hydraulics and kinetics to obtain robust and yet simple models for HF CWs. It was proposed that the volumes estimated by the identification method can be used for wetland design.

Rousseau (2005) developed a reaction model that is coupled with a network of CSTRs for describing water flow. The CSTR approach assumes a vertical uniform distribution of substrates, intermediates, products, and bacteria, which may not be the case for HF CWs. Vertical mixing between the CSTRs was therefore introduced to model vertical gradients in the filter bed. The Activated Sludge Model (ASM; Henze et al., 2000) is used to model microbial conversions. Particulate substances are incorporated into the model, to investigate clogging and long-term assessment of hydraulic characteristics. Additionally, long-term simulations incorporate meteorological data. The developed model considers microbiological and plant-related processes affecting COD and nitrogen in HF CWs. Phosphorus removal is not considered, and it is therefore assumed that P concentrations are nonlimiting for microbial and plant growth. Aerobic and anoxic microbial carbon and nitrogen conversion processes are based on ASM processes. As oxygen transfer in HF CWs is limited, anaerobic microbial processes are considered. The competition between sulfate reducing and methanogenic bacteria is modeled as described by Kalyuzhnyi and Fedorovich (1998). To avoid microbial inhibition due to sulfide accumulation, an inverse pathway was foreseen by adding sulfide-oxidizing bacteria to the model. Under normal operating conditions, it is assumed that suspended solids are completely removed near the inlet. Wash-out of solids proportional to the flow rate is foreseen only at higher flow rates. It is assumed that detached parts of the biofilm are retained within the pores and metabolized until washed out by a peak flow. The plant growth and decay model was deliberately kept simple, describing plant growth using growth rates that depend on ammonium and nitrate availability. Plant material is expressed as COD, which allows smooth integration with the COD-based model description of the microbial processes. Other plant-related processes include decay, senescence, and physical degradation, and root oxygen loss. A pilot-scale HF CW could be successfully modeled using this approach, although uncertainties have been noted regarding wastewater fractionation and low measurement frequencies at the experimental plant. Rousseau (2005) mentioned that, at the current state, the model cannot be used for design purposes, but it might provide wetland scientists with a framework to discuss experimental results. The modeling exercise helped show the importance of sulfate processes in HF CWs. Research needs mentioned by Rousseau (2005) are (i) the physical reaeration process, in relation to parameters such as water velocity, porosity, water depth, and water temperature; and (ii) the behavior of particulate substances in the gravel matrix (i.e., filtration and settling processes, and resuspension).

Reactive Transport Models for Variably Saturated Conditions

The multicomponent reactive transport module CW2D (Langergraber, 2001) was developed to describe the biochemical transformation and degradation processes in SSF CWs. CW2D was incorporated into the HYDRUS variably saturated water flow and solute transport program (Langergraber and Šimůnek, 2006; Šimůnek et al., 2006a, 2006b). The HYDRUS program numerically solves the Richards equation for saturated–unsaturated water flow and the convection–dispersion equation for heat and solute transport. The flow equation incorporates a sink term

to account for water uptake by plant roots. The solute transport equations consider convective–dispersive transport in the liquid phase, diffusion in the gaseous phase, and nonlinear nonequilibrium reactions between the solid and liquid phases (Šimůnek et al., 2006b). The CW2D module considers 12 components and 9 processes. The components include dissolved oxygen; organic matter (three fractions of different degradability, i.e., readily and slowly biodegradable, and inert); ammonium, nitrite, nitrate, and nitrogen gas; inorganic phosphorus; and heterotrophic and two species of autotrophic microorganisms. Organic nitrogen and organic phosphorus are modeled as nutrient contents of the organic matter and are calculated as a percentage of COD. The biochemical elimination and transformation processes are based on Monod-type expressions used to describe the process rates. All process rates and diffusion coefficients are temperature dependent. The processes considered are hydrolysis, mineralization of organic matter, nitrification (modeled as a two-step process), denitrification, and a lysis process (as the sum of all decay and loss processes) for the microorganisms. CW2D assumes a constant concentration of microorganisms (and other compounds) in each finite element. The thickness of the biofilm is not considered. The mathematical structure of CW2D is based on the mathematical structure of the ASMs (Henze et al., 2000). Langergraber (2005) investigated the plant uptake models provided by HYDRUS, which describe nutrient uptake coupled with water uptake, and concluded that it was possible to simulate plant uptake in high-loaded systems (e.g., systems treating mechanically pretreated municipal wastewater). For low-strength wastewater, the simulation results indicate that these models overestimate potential nutrient uptake. Oxygen release via roots can be modeled in a way similar to nutrient uptake (Toscano et al., 2006). For a detailed discussion of the CW2D module, see Langergraber and Šimůnek (2005). In the last years, several groups have used CW2D for applications besides treating domestic wastewater, such as CWs polishing the effluent of a wastewater treatment plant for reuse purposes (Toscano et al., 2006) and for treatment of combined sewer overflow (Dittmer et al., 2005; Meyer et al., 2006; Henrichs et al., 2007).

The recently developed model by Ojeda et al. (2006) is based on the two-dimensional finite element code RetrasoCodeBright (RCB), which has been applied in hydrogeological studies to simulate reactive transport of dissolved and gaseous species for nonisothermal saturated or unsaturated flow domains (Rezaei et al., 2005; Saaltink et al., 2003). In RCB, a first module calculates the flow properties which are used by a second module to calculate reactive transport. Ojeda et al. (2006) modified RCB to include the most significant biochemical pathways for organic matter removal in HF CWs. The reactive transport model, based on work by Van Cappellen and Gaillard (1996), basically consists of six microbial kinetic reactions: hydrolysis, aerobic respiration, nitrification, denitrification, sulfate reduction, and methanogenesis. The degradation rate associated with each of the six kinetic equations, except for hydrolysis, is described by multiplicative Monod-type expressions. The hydrolysis process is modeled by an exponential function describing the total suspended solids removal that occurs near the inlet of the bed. Phosphorus transformations, biofilm growth, and oxygen leaking from macrophytes have not been considered. Until now, the model has been used to evaluate the importance of the organic loading rate on the removal efficiencies of experimental HF CWs.

McGechan et al. (2005b) adapted a nitrogen-cycling sub-model from a soil model for CWs. Pools in the model represent organic material with high BOD, ammonium, and nitrate. Microbiologically controlled transformations between pools are represented by first-order exponential kinetics, with nitrogen finally lost to the atmosphere either by ammonia volatilization or by denitrification to gaseous nitrogen or nitrous oxide. The model was set up to represent an experimental system with one HF and three VF CWs. A simple model was implemented for describing the hydraulic behavior of the CWs. Based on the assumption of plug flow, the HF bed was considered to consist of a number of equal imaginary vertical slices, each with the same residence time. The individual vertical slices were subdivided into equal horizontal layers, each containing a proportion of the plant roots. For the HF bed slices, this represents a flow rate over the time step, so the rate constant is a true time constant. However, for the VF beds, it is simply a flow over the time that the effluent takes to pass through the individual bed, so the rate constant does not include time units. Rate constants have been selected so that simulated results are a reasonable approximation of measurements from the experimental system. The model has been developed to assist in optimizing design parameters for new systems (including the number and sequence of reedbed types, dimensions, and flow rates) for various incoming contaminant concentrations and target water-purity standards. An extension of the model (McGechan et al., 2005a) simulates oxygen transport through the water by diffusion and convection and through the macrophyte plants to the microorganisms that reside on their roots. Parameter values have been selected to fit data from a functioning reedbed processing sewage in a rural community. This reedbed achieves a large reduction in ammonium concentration in the effluent. Since it is unlikely that so much ammonium could have been lost by volatilization alone, this implies the rapid transport of oxygen to microorganisms that convert the ammonium to nitrate. The rate found was substantially higher than could be explained by diffusion and convection through the water alone, suggesting an important role for oxygen transport via the plants to the roots.

Wanko et al. (2006b) developed a model combining chemical reaction engineering and the mechanistic approach to transport in a one-dimensional domain. The main purpose of the model was to investigate oxygen transport in vertical flow filters with intermittent loading. To achieve this, oxygen was modeled in both gaseous and dissolved form. The model considers the hydrodynamics of the porous medium, development of the active biomass, transport of substrate, and oxygen transfer and consumption. The vertical flow in a nonsaturated porous medium is described by the Richards equation. Macroscopic transport is considered for one substrate and active biomass in suspension in the porous medium liquid phase (i.e., considering biomass that is detached from the filter sand and washed out). Biomass growth is described by Monod-type kinetic functions. The numerical solution is based on finite elements and uses a splitting operator technique that has the advantage of a separate solution of the convection, dispersion, and kinetics equations; each using appropriate numerical techniques. The numerical implementation has been verified by comparing simulation results to analytical solutions. To date, only results for calibrating the flow model have been published (Wanko et al., 2006b). Experiments with sand columns have been performed to gain data for calibration and validation of oxygen transport (Wanko et al., 2006a).

Freire et al. (2006) used a chemical engineering approach to model a VF CW. The main aim was to develop a model for simulating the treatment of industrial wastewater from textile industries, including dyes. The pilot-scale VF CW was operated in a continuous feeding mode. The study had as its main objective to model the pilot plant and to investigate the effect of higher oxygen transfer rates in the intermittent feeding mode on treatment efficiency. The mechanistic model, which is in an early stage of development, considers the hydraulic and kinetic properties of a pilot-scale VF CW used to treat the acid orange 7 (AO7) azo dye. The model is able to deal with intermittent and continuous feeding modes. The hydraulic submodel considers three reactors: two CSTRs and a dead zone volume. Flooding events and changes in bed permeability have been taken into account to describe clogging of the filter. Transport of AO7 considers the mass balance, and degradation is modeled using first-order kinetic rates. It was shown that the model could match the results from the continuous feeding mode well. However, the interpretation of the results from simulations of the intermittent feeding mode seemed to be more difficult, as the simulated removal efficiency in the continuous operation was higher compared to that in intermittent feeding. This simulated result was in contrast to the expected results. The authors concluded that the model needed to be developed further before it can be used in practice.

Applications Using CW2D

Vertical Flow Constructed Wetlands for Wastewater Treatment

Indoor Vertical Flow Pilot-Scale Constructed Wetlands

Experiments have been performed at indoor VF pilot-scale constructed wetlands (PSCWs, Fig. 3) in the technical laboratory hall of the Institute of Sanitary Engineering at BOKU since 2000 (Langergraber, 2003; Langergraber and Šimůnek, 2005; Langergraber et al., 2007). Each of the up to 10 parallel operating PSCWs had a surface area of 1 m². The PSCWs were loaded four times per day with mechanically pretreated municipal wastewater and have either been planted with *Arundo donax* L., *Miscanthus gigantean*, or left unplanted. Figure 4 provides a schematic representation of a PSCW. The 60-cm main layer consists of sandy substrate with a grain size of either 0.06–4 mm ($d_{10} = 0.2$ mm; $d_{60} = 0.8$ mm) or 1–4 mm ($d_{10} = 2$ mm; $d_{60} = 3$ mm). The intermediate layer (gravel 4–8 mm) prevents fine particles from being washed out into the drainage layer (gravel 16–32 mm). Different organic and hydraulic loads were applied.

For the numerical simulations, a vertical cross-section of the main layer was considered. The transport domain was discretized into 11 columns and 40 rows. This resulted in a two-dimensional finite element mesh consisting of 440 nodes and 780 finite elements. An atmospheric boundary condition was assigned to the top of the system (a constant pressure head boundary condition of -2 cm).

Table 1 shows two parameter sets of the van Genuchten–Mualem model (van Genuchten, 1980) of the soil hydraulic properties used in simulations of water flow. The “measured K_s + porosity” parameter set uses measured values of porosity and saturated hydraulic conductivity K_s and the default residual water content and shape parameters for sand provided by



FIG. 3. Indoor pilot-scale constructed wetlands at the technical laboratory hall at the University of Natural Resources and Applied Life Sciences, Vienna (BOKU).

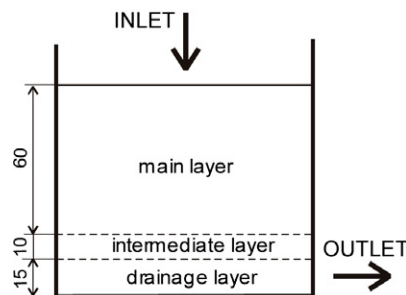

FIG. 4. Schematic representation of the indoor pilot-scale constructed wetland (values are in centimeters).

HYDRUS. The second parameter set, obtained by inverse simulation, shows results reported by Langergraber (2003). Measured effluent flow rates and water content measurements at a depth of 25 cm were used to estimate the soil hydraulic parameters using the inverse simulation routine provided by HYDRUS. Figure 5 compares the measured and simulated effluent flow rates using these two parameter sets. The simulated effluent flow rates are already close to the data when using measured values of porosity and saturated hydraulic conductivity (the “measured K_s + porosity” parameter set). This indicates that it is necessary to measure at least

TABLE 1. Fitted soil hydraulic parameters of the van Genuchten–Mualem model for the 0.06- to 4-mm main layer (shape parameters α , N , and L [van Genuchten, 1980]; subscript w and s: water and substrate, respectively).

Parameter	Residual water content θ_r	Saturated water content θ_s	Shape parameters			Saturated hydraulic conductivity K_s
			α	N	L	
	$m_w^3 m_s^{-3}$	m_s^{-3}	m_s^{-1}			$m_s h^{-1}$
Measured K_s + porosity	0.045	0.30	14.5	2.68	0.5	1.17
Langergraber (2003)	0.056	0.289	12.6	1.92	0.5	0.84

the porosity and the saturated hydraulic conductivity of the filter material to obtain reasonable simulation results for water flow.

Simulation results for water flow, single-solute transport (tracer experiments), and multicomponent reactive solute transport have been presented by Langergraber (2003) and Langergraber and Šimůnek (2005). Table 2 shows measured and simulated concentrations of ammonia and nitrate nitrogen for the two different substrates used. The different levels of the $\text{NO}_3\text{-N}$ effluent concentrations for the two substrates could be simulated. The effluent concentrations of $\text{NO}_3\text{-N}$ for the 1- to 4-mm substrate are higher because hydrolysis produced less readily degradable organic matter that could be used for denitrification in deeper layers. In general, the simulation results showed a good match to the measured data when the hydraulic behavior of the system could be well described. The good match of experimental data to reactive transport simulations can be obtained using literature values for the CW2D model parameters (Langergraber, 2003; Langergraber and Šimůnek, 2005).

Comparison of Measured and Simulated Distribution of Microbial Biomass

CW2D, as well as the underlying ASMs, are based on mass balances for COD. The C and N content of the biomass was measured and converted to microbial COD using factors based on stoichiometry (Langergraber et al., 2007).

Tietz et al. (2007) applied several methods to measure microbial and bacterial biomass parameters, including conversion of bacterial abundance (determined by microscopic direct counts) into biomass by measurement of the cell volume, fumigation–extraction for biomass C and N, adenosine triphosphate measurements for biomass C, and substrate-induced respiration (SIR) for biomass C. Converting the measured data into biomass COD results in mean values of 3400 to 5100 $\text{mg COD g}_{\text{DW}}^{-1}$ (where DW is dry weight of the substrate, i.e., sand) for the first centimeter of the main layer, 1100 to 2600 $\text{mg COD g}_{\text{DW}}^{-1}$ from 1 to 5 cm, and 640 to 1400 $\text{mg COD g}_{\text{DW}}^{-1}$ from 5 to 10 cm, respectively. Most of the biomass could be found in the upper 10 cm of the VF bed (Langergraber et al., 2007).

Simulated microbial biomass COD in the first centimeter of the main layer is between 5600 and 3400 $\text{mg COD g}_{\text{DW}}^{-1}$ (the range of the measured values) when using heterotrophic lysis rates of between 0.25 and 0.35 d^{-1} . Figure 6 compares

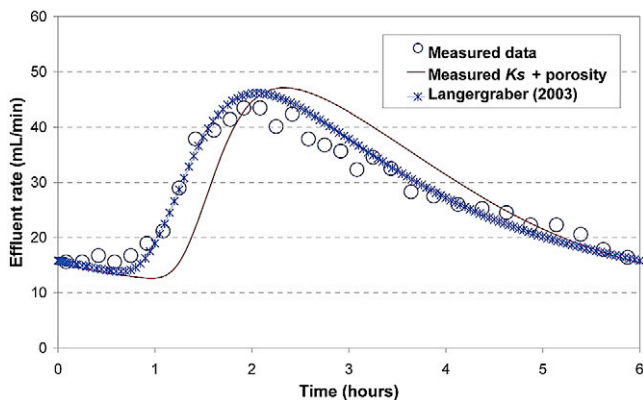

FIG. 5. Measured and simulated effluent flow rates for a single feeding of 10 L (“Measured K_s +porosity” and “Langergraber (2003)” represent the parameter sets from Table 1, according to Langergraber and Šimůnek, 2005).

TABLE 2. Median values of measured and simulated influent and effluent concentrations for $\text{NH}_4\text{-N}$ and $\text{NO}_3\text{-N}$ (adapted from Langergraber and Šimůnek, 2005).

Parameter	Influent	Effluent 0.06–4 mm substrate		Effluent 1–4 mm substrate	
		Measured	Measured	Simulation	Measured
$\text{NH}_4\text{-N}$	60.0	0.15	mg L^{-1}		0.16
$\text{NO}_3\text{-N}$	3.0	38.5	41.1	50.0	63.0

calculated (from SIR) and simulated microbial biomass COD in different depths of the main layer for a heterotrophic lysis rate of 0.30 d^{-1} . When comparing measured and simulated biomass COD in different depths of the main layer, simulations seem to overpredict biomass COD in 1- to 5-cm depth and underpredict biomass COD in the 5- to 10-cm depth. This could be an indication that the influence of biomass growth on the hydraulic properties has to be considered in the model (Langergraber et al., 2007).

Outdoor Vertical Flow Pilot-Scale Constructed Wetlands

Outdoor experiments have been performed at experimental CWs located at the wastewater treatment plant in Ernstthofen (Lower Austria, Fig. 7). The experimental plant, in operation since 2003, consists of three parallel operating VF beds with a surface area of about 20 m^2 each operated with intermittent loading (Langergraber, 2007). The organic loads for Beds 1 through 3 have been 20, 27, and 40 $\text{g COD m}^{-2} \text{d}^{-1}$, which correspond to hydraulic loading rates of 32.2, 43.0, and 64.7 mm d^{-1} . The main layer of the filter consists of 50 cm sandy substrate (gravel size 0.06–4 mm, $d_{10} = 0.2 \text{ mm}$; $d_{60} = 0.8 \text{ mm}$). The beds are planted with common reed (*Phragmites australis*).

The data gained from this experiment have been used to verify the temperature model incorporated into CW2D (Langergraber, 2007). The width of the transport domain in the numerical simulations was 4 m, and its depth was 0.8 m. The transport domain itself was discretized into 31 columns and 33 rows, resulting in a two-dimensional finite element mesh consisting of 1023 nodes and 1920 triangular finite elements. An atmospheric boundary condition was assigned to the top of the system representing the influent distribution system, and a

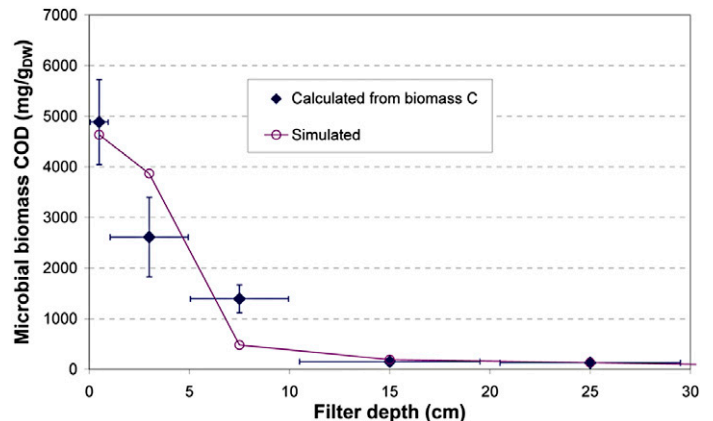

FIG. 6. Calculated and simulated microbial biomass chemical oxygen demand (COD) in different depths of the main layer (adapted from Langergraber et al., 2007) (DW: dry weight).



FIG. 7. Outdoor experimental constructed wetlands in Ernsthofen (Lower Austria).

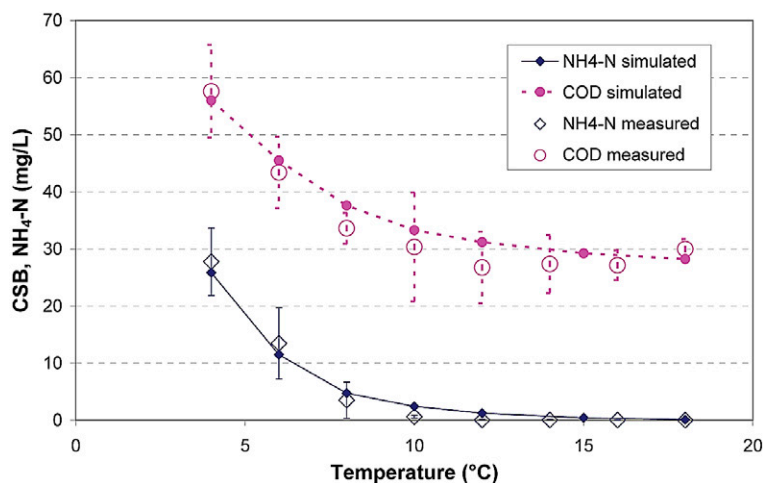

FIG. 8. Measured and simulated chemical oxygen demand (COD) and NH₄-N effluent concentrations using the modified parameter set (Langergraber, 2007).

constant pressure head boundary condition (constant head of -4 cm) was assigned to one side of the drainage layer.

Results for water flow comparing measured and simulated effluent flow rates and the cumulative effluent of the experimental CW are shown in Langergraber (2007). Simulated effluent flow rate and cumulative effluent flow match the measured data well. Using the calibrated flow model, the effluent concentrations during summer could be simulated using the standard CW2D parameter set (Langergraber and Šimůnek, 2005). However, measured COD and NH₄-N effluent concentrations at low temperatures could not be simulated because hydrolysis and nitrification at low temperatures were overpredicted. The standard CW2D parameter set considers temperature dependencies only for maximum growth, decay, and hydrolysis rates. Because experience from activated sludge systems showed that considering temperature dependencies for the half-saturation constants of hydrolysis and nitrification improves the model predictions, they have therefore been included in ASM parameter sets (e.g., Bornemann et al., 1998). Figure 8 shows measured and simulated COD and NH₄-N effluent concentrations using a modified parameter set that includes temperature dependencies for the half-saturation constants of hydrolysis and nitrification. Using this modified parameter set, it was possible to simulate the COD and NH₄-N effluent concentrations at low temperatures (Langergraber, 2007).

Vertical Flow Constructed Wetlands for Combined Sewer Overflow Treatment

CW2D was used to model VF CWs for the treatment of combined sewer overflow (CSO) by Dittmer et al. (2005), Meyer et al. (2006) and Henrichs et al. (2007). Some of the differences between using wetlands for wastewater and for CSO treatments are the loading regime and the quality parameters of the inflow. For CSO treatment, the succession of loading events and dry periods is characterized by the stochastic nature of rainfall and the runoff behavior of the catchment area. On the one hand, extreme cases involve a permanent loading for weeks, while several months without any loading event are possible at the other extreme. To reach the main treatment objective, the detention and reduction of peak flows (Dittmer et al., 2005), throttle valves are applied to limit the maximum effluent flow rate and therefore the flow

velocity in the filter itself. For simulation purposes, the maximum allowed effluent flow rate had to be implemented (Langergraber and Šimůnek, 2006).

The first simulations were performed for lab-scale columns with a diameter of 19 cm (Dittmer et al., 2005). The 100-cm main layer consisted of sand (grain size 0–2 mm, effective size 0.1 mm, coefficient of uniformity 2.8). The test site was comprised of six columns all fed identically. The columns were loaded once a week with 15.7 L of synthetic sewer, which corresponds to a loading rate of 0.5 m per event. The filtration rate of Columns 1 to 4 was controlled manually by a throttle valve, whereas Columns 5 and 6 had free drainage. For the simulation, a structured two-dimensional finite element mesh with 105 rows and 3 columns was used, resulting in 315 nodes and 416 elements. The storage volume was modeled by a virtual layer with a pore volume of 100% and a residual water content of 0%. On the top of the virtual layer, an atmospheric boundary condition was applied, while a free drainage or seepage face with maximum allowed flux was used at the bottom (Dittmer et al., 2005).

Figure 9 compares simulated effluent flow rates for a column with free drainage and a limited seepage face flux boundary condition. The maximum flow in the controlled effluent rate case (right) corresponds to 1 L/h. While in the unrestricted flow case, the bulk of the water passed through the filter bed in about 1 h, in the flow restricted case this happened in about 15 h.

Figure 10 shows measured and simulated breakthrough curves of a tracer experiment performed for Column 6 with free drainage. Figure 11 shows breakthrough curves for Column 4 and Column 2, with controlled effluent rates of 5 and 1 L/h, respectively. Using the transport parameters obtained from the free drainage simulations (Column 6), the tracer experiments with controlled effluent rate could be simulated well.

For multicomponent reactive transport simulations, good results could be achieved when considering the different composition of CSO compared to domestic wastewater (Dittmer et al., 2005) and considering adsorption for COD fractions (Henrichs et al., 2007). Figure 12 shows, as an example, the simulated effluent concentrations of COD and its fractions for a lab-scale experiment with a controlled effluent rate. Using the parameters obtained from lab-scale experiments, it was also pos-

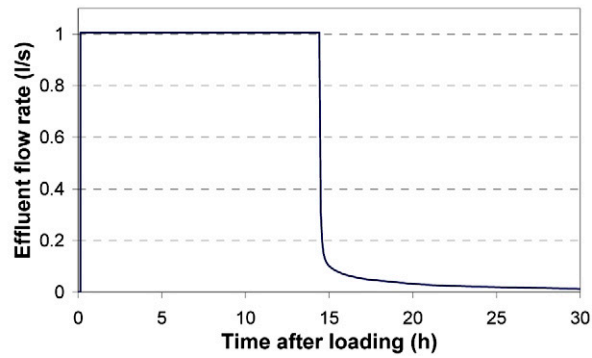
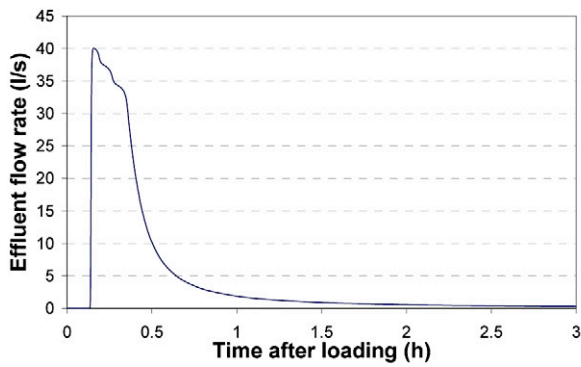

FIG. 9. Comparison of simulations with free drainage boundary condition (left) and controlled effluent rate (right).

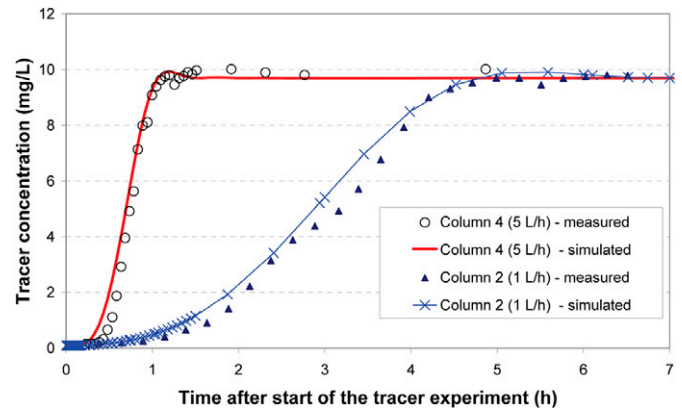
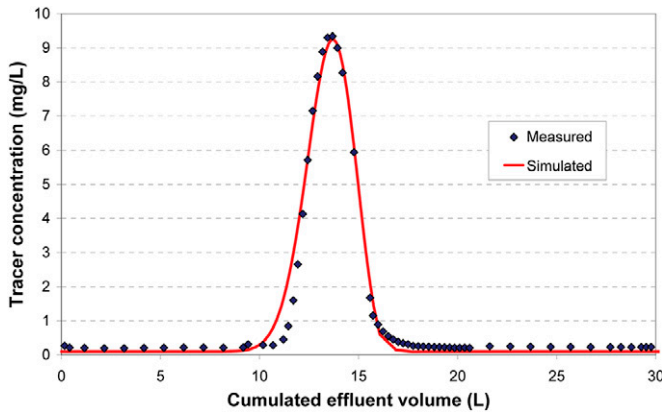

FIG. 10. Measured and simulated breakthrough curves of Column 6 with free drainage (Dittmer et al., 2005).

FIG. 11. Measured and simulated breakthrough curves of Column 4 and Column 2 for a controlled effluent rate of 5 and 1 L h⁻¹, respectively (Langergraber and Šimůnek, 2006).

sible to successfully simulate single events of field experiments. The consideration of the adsorption process for COD fractions is important for controlled effluents as the flow velocity in the filter is low. For vertical filters with free drainage, adsorption processes for COD fractions can be neglected due to the high flow velocities in the filter. Henrichs et al. (2007) further showed that problems occur when simulating long-term experiments that include long dry periods. These problems might be caused by different degradation processes during dry periods that may not be represented well in CW2D.

Two Stage Horizontal Flow and Vertical Flow Pilot-Scale Constructed Wetlands

The experimental plant used for these experiments is located in San Michele di Ganzaria (Eastern Sicily, Italy) and has been in operation since June 2004 (Toscano et al., 2006). Each of the four parallel lines consists of two SSF beds in series (Fig. 13). The plant was designed to treat effluents from both the primary and secondary settlers of the conventional wastewater treatment plant (tricking filter). For each line, the first stage consists of a HF bed (HF1–4, depths 0.6 m, volcanic gravel, 10–15 mm), while the second stage uses an intermittently loaded VF bed for two lines (VF5–6, 0.5 m main layer, volcanic sand, 0.06–4 mm) and a HF bed for the other two (HF7–8). Each bed has a rectangular shape with a surface area of 4.5 m² (1.5 × 3.0 m). Lines 1 and 3 are planted with reed (*Phragmites australis*) whereas Lines 2 and 4 are unplanted.

Simulations were performed for Lines 1 and 2 of the pilot plant for secondary and tertiary treatment. To

simulate the HF beds, a longitudinal section (3.0-m length and 0.6-m depth, with 16 rows and 25 columns, resulting in 400 nodes and 720 finite elements) was used; the VF beds used a vertical cross-section (1.5-m width and 0.75-m depth; 25 rows and 16 columns; 400 nodes and 720 finite elements). Atmospheric boundary conditions have been used for the influent boundaries, and constant pressure head boundary conditions for the effluent boundaries.

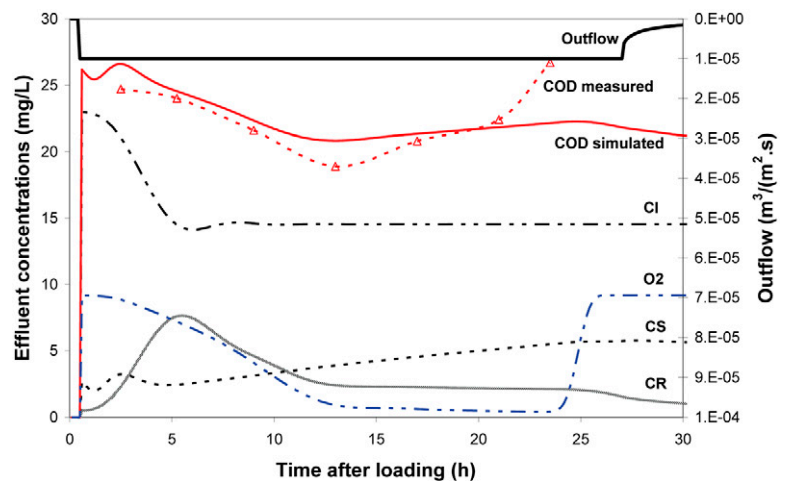

FIG. 12. Effluent concentrations of chemical oxygen demand (COD) and its fractions with COD adsorption and controlled effluent rate (adapted from Henrichs et al., 2007; O₂: dissolved oxygen; CR, CS, CI: readily biodegradable, slowly biodegradable, and inert organic matter, respectively).

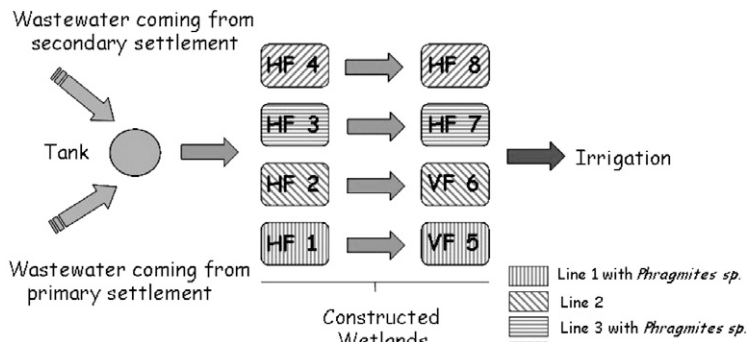

FIG. 13. Schematic sketch of pilot plant in San Michele di Ganzaria (Toscana et al., 2006).

The flow model has been calibrated using effluent flow rate measurements of the VF beds as well as the measured porosity and saturated hydraulic conductivities of the filter material. The times of the loadings of the VF beds have been recorded. The influent flow rate for the HF beds was calculated by providing the fixed amount of a single loading for VF beds and the recorded interval between two successive loadings. Figure 14 compares measured and simulated breakthrough curves for a tracer experiment on Line 2 (HF2 + VF6). The simulation results matched the measured data well

For secondary treatment, simulations were performed for Line 1 (with vegetation) and Line 2 (without vegetation). The effects of plant roots, oxygen release, and nutrient uptake have been taken into account. The root zone in the HF bed was set to be half the depth of the bed (30 cm) (Rousseau, 2005). Oxygen release was assumed to be $5 \text{ g O}_2 \text{ m}^{-2} \text{ d}^{-1}$ (Vymazal et al., 1998). The evapotranspiration rate was calculated to be 7.4 mm d^{-1} , and it was assumed that ammonia and nitrate are taken up by plants with the same preference. Figure 15 shows the simulated oxygen concentration profile in HF1 with plants. The oxygen concentration increased up to about 0.2 mg L^{-1} in the upper half of HF1, with higher concentrations of up to 0.3 mg L^{-1} very close to the inlet.

Table 3 shows measured influent and effluent, and simulated effluent concentrations for HF1 and HF2. No difference could be observed for the effluent COD concentrations of the planted and unplanted bed. However, the effluent $\text{NH}_4\text{-N}$ concentrations of

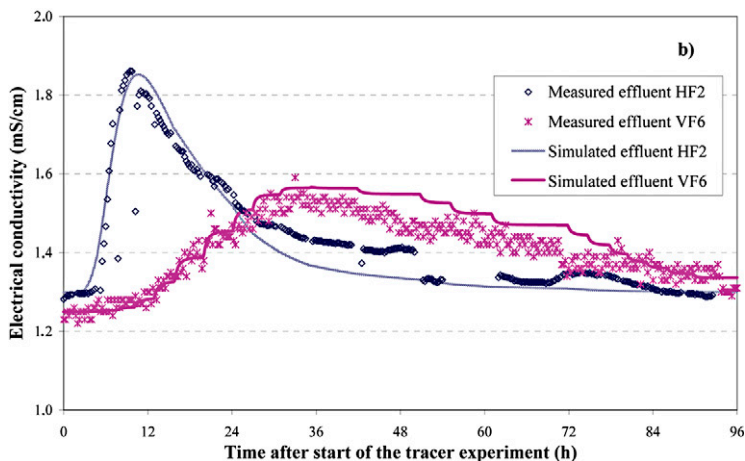

FIG. 14. Measured and simulated breakthrough curves for a tracer experiment on Line 2 (HF2 + VF6) (Toscana et al., 2006).

the planted bed (HF1) were significantly lower compared with the unplanted bed (HF2). By considering the effects of plants (i.e., oxygen release by roots and nutrient uptake), it was possible to model the differences in the $\text{NH}_4\text{-N}$ effluent concentrations in planted and unplanted HF beds.

Two-Stage Pilot-Scale Downflow and Upflow Constructed Wetland

Simulation results for a two-stage pilot-scale CW for treating surface water (Langergraber, 2003; Langergraber and Šimůnek, 2005) are included here to show an application for a more complicated flow domain geometry. The system was designed for the treatment of heavily polluted surface water from shallow lakes in China (Grosse et al., 1999) with influent concentrations of 5 to $10 \text{ mg NH}_4\text{-N L}^{-1}$. The total surface area of the two-stage system was 2 m^2 , divided into downflow and upflow chambers (surface area is 1 m^2 each). The inlet was situated on the top of the downflow chamber; the effluent was collected on the top of the upflow chamber by means of perforated pipes. There was a separating wall between the downflow and upflow chambers (Perfler et al., 1999; Fig. 16). The main layer (depths of 55 cm downflow and 45 cm upflow) was filled with sand (gravel size 0.06–4 mm). The hydraulic loading rate was 50 L every 2 h (i.e., 600 L d^{-1}).

An unstructured two-dimensional finite element mesh was used for simulations consisting of 1135 nodes and 2057 elements (Fig. 17). The inlet distribution pipe at the top of the downflow chamber was modeled as a time dependent atmospheric boundary condition. Outlet (effluent) pipes were modeled as circular openings in the transport domain with a seepage face boundary condition.

Langergraber (2003) showed that taking into account stagnant (immobile) regions of the pore water resulted in a much better match of the simulated concentration data for the tracer experiment, compared with instances when only mobile pore water was considered. Langergraber and Šimůnek (2005) showed several simulation results using CW2D. Figure 18 shows as an example of simulated and measured concentrations of $\text{NH}_4\text{-N}$ and $\text{NO}_3\text{-N}$ in a cross-section of the downflow chamber.

Discussion

Until now, very few models to simulate removal processes in SSF CWs have been developed. Of these models, several are applicable to HF CWs, as they only consider saturated water flow using, for example, a tanks-in-series approach (Chen et al., 1999; Wynn and Liehr, 2001; Marsili-Libelli and Checchi, 2005; Rousseau, 2005) or are only applicable for constant flow rates (Mashauri and Kayombo, 2002; Mayo and Bigambo, 2005). Three of these six models considered only carbon trans-

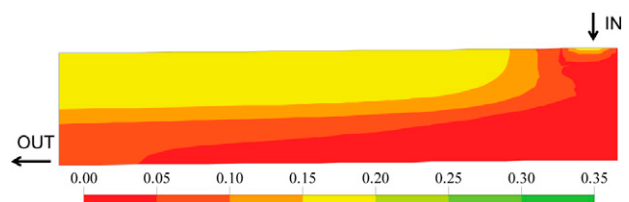

FIG. 15. Simulated oxygen concentration profile (mg L^{-1}) in HF1 with plants (root depth is half of bed depths).

TABLE 3. Measured influent and effluent concentrations (mean values and standard deviation in parentheses) and simulated effluent concentrations (mg L^{-1}) for HF1 and HF2.

Parameter		COD	$\text{NH}_4\text{-N}$	$\text{NO}_3\text{-N}$	$\text{NO}_2\text{-N}$
Influent	Measured	63.9 (3.3)	22.1 (1.9)	0.18 (0.38)	0.34 (0.10)
Effluent HF1 (planted)	Measured	47.5 (2.8)	16.6 (1.2)	0.06 (0.05)	0.18 (0.17)
	Simulated	44.4	17.2	0.02	2.82
Effluent HF2 (unplanted)	Measured	48.2 (4.1)	20.4 (0.6)	0.02 (0.01)	0.12 (0.11)
	Simulated	50.6	21.5	6E-05	1E-04

formation processes (Chen et al., 1999; Mashauri and Kayombo, 2002; Marsili-Libelli and Checchi, 2005), one only nitrogen transformations (Mayo and Bigambo, 2005), and the remaining two both carbon and nitrogen transformations (Wynn and Liehr, 2001; Rousseau, 2005). The most advanced of these models is the one developed by Rousseau (2005), who implemented a reaction model presented in matrix notation based on the mathematical structure of the ASMs that includes the description of aerobic, anoxic, and anaerobic processes. However, until now Rousseau's model (2005) has only been applied to one pilot-scale HF CW.

Besides CW2D (Langergraber, 2001), there have been four models described in the literature that consider vadoze zone processes. The other models are in a very early stage of development. The most advanced one is the model developed by Ojeda et al. (2006), which considers processes affecting solids, organic matter, nitrogen, and sulfur. The model was developed primarily for HF CWs, but, because of the underlying flow model, it is also capable of simulating VF CWs. The model developed by McGechan et al. (2005a, 2005b) considers pools of organic matter, ammonium, and nitrate, as well as oxygen. Microbiologically controlled transformations are defined between pools. The model developed by Wanko et al. (2006b) considers organic matter removal and

oxygen transport, whereas the model of Freire et al. (2006) only describes the removal of the dye AO7. Like CW2D/HYDRUS, the models developed by Ojeda et al. (2006) and Wanko et al. (2006b) use the Richards equation for describing variably saturated flow, whereas the other models use either different layers (McGechan et al., 2005a, 2005b) or a combination of CSTRs and dead zones (Freire et al., 2006).

The multicomponent reactive transport module CW2D (Langergraber, 2001) is able to describe the biochemical transformation and degradation processes for organic matter, nitrogen, and phosphorus in SSF CWs. The experience showed that simulation results match the measured data when the hydraulic behavior of the system can be described well. A good match of experimental data to reactive transport simulations can then be obtained using literature values for the CW2D model parameters (Langergraber, 2003; Langergraber and Šimůnek, 2005). For practical applications, it is advisable to measure at least the porosity and saturated hydraulic conductivity of the filter material to obtain reasonable simulation results for water flow.

Being incorporated into the HYDRUS variably saturated water flow and solute transport program (Langergraber and Šimůnek, 2006), CW2D is easy to use and has been applied by other research groups, for example, for CWs polishing the effluent of a wastewater treatment plant for reuse purposes (Toscano et al., 2006) and treatment of combined sewer overflow (Dittmer et al., 2005; Meyer et al., 2006; Henrichs et al., 2007).

Although CW2D has been applied several times, there are still a number of research needs that must be addressed before it can be used as a reliable design tool for CWs. As already suggested by Langergraber (2003), a module that will enable the description of the influence of particulates and biomass growth on the hydraulic properties of the filter needs to be incorporated. The module should be able to describe pore size reductions due to the settling of suspended solids and bacteria growth. Langergraber et al. (2007) conclude that the influence of biomass growth on the hydraulic properties must be included for a better match of simulated and measured data on biomass distribution in a VF filter.

Another research need is the development of experimental methods that estimate CW2D model parameters, as none are currently available (Langergraber and Šimůnek, 2005). Andreottola et al. (2007) presented a respirometric technique to measure the

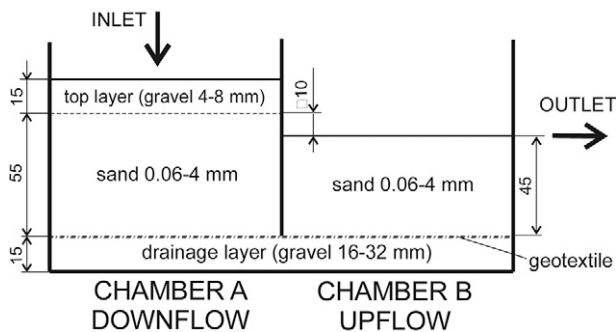

FIG. 16. Schematic representation of the two-stage vertical flow constructed wetland (values are in cm).

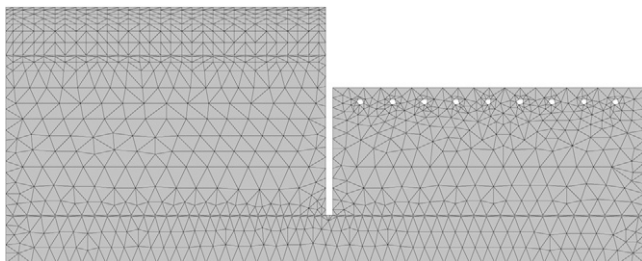

FIG. 17. Two-dimensional mesh of the two-stage vertical flow constructed wetland.

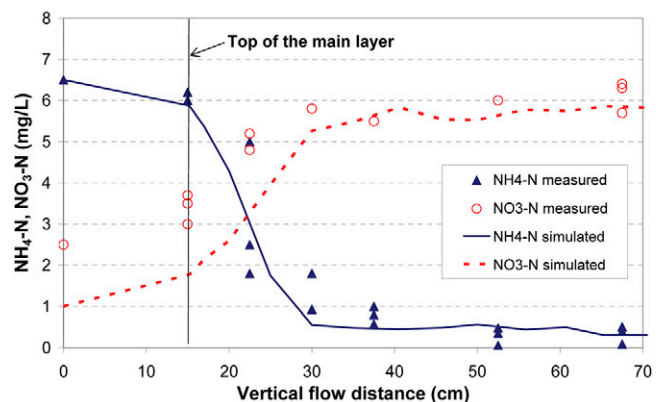

FIG. 18. Simulated and measured concentrations of $\text{NH}_4\text{-N}$ and $\text{NO}_3\text{-N}$ in a cross-section of the downflow chamber (Langergraber and Šimůnek, 2005).

kinetics of organic matter oxidation and nitrification using columns that simulate cores of VF CWs. The following kinetic parameters can be extracted from the respirograms: maximum oxidation rate of readily biodegradable COD, maximum nitrification rate, and endogenous respiration. The method proposed by Andreottola et al. (2007) seems promising for use with the CW2D module.

For the simulation of VF beds for CSO treatment, the degradation processes in dry periods should be different than those modeled in CW2D for organic matter degradation and nitrification (Henrichs et al., 2007). These differences have to be investigated in more detail and possibly included within CW2D.

As anaerobic processes play a major role in HF CWs, the inclusion of anaerobic processes as described in the models of Rousseau (2005) and Ojeda et al. (2006) may have to be considered as well.

Summary and Conclusions

The previous sections have reviewed numerical models describing processes in subsurface flow constructed wetlands. Several authors aimed for modeling the hydraulic behavior of the system including tracer experiments only. There are few published models that are able to model the biochemical transformation and degradation processes that occur in the complex system subsurface flow constructed wetland.

Models describing reactive transport under water flow saturated conditions can only be used to model horizontal flow constructed wetlands. Six models have been reviewed in this category that use either a series or a network of ideal reactors (continuously stirred tank reactors and/or plug flow reactors), or are only applicable for constant flow rates to model water flow. Transformation and removal processes are described for organic matter and/or nitrogen.

Modeling vertical flow constructed wetlands with intermittent loading requires transient variably saturated flow models as these systems are highly dynamic, which adds to the complexity of the overall system. Five models of differing complexities have been published that consider variably saturated flow and reaction models for constructed wetlands. Four of these models are in the rather early stages of development. For the multicomponent reactive transport module CW2D, several applications have been published that include treatment of domestic wastewater with vertical flow constructed wetlands, treatment of combined sewer overflow, and polishing of treated wastewater. The usage of CW2D, an extension of the variably saturated water flow and solute transport program HYDRUS, was also described.

Based on the experience gained by applying CW2D, the following conclusions can be drawn: (i) a good match to measured data can be achieved when the hydraulic behavior of the system is correctly described; (ii) it is thus suggested, for practical applications, to measure at least the porosity and the saturated hydraulic conductivity of the porous filter material; (iii) the description of the influence of particulates and biomass growth on the hydraulic properties of the filter in the model would increase its prediction quality; (iv) research is needed to develop experimental methods for estimating the kinetic parameters of CW2D; (v) degradation processes in very dry periods occurring when treating combined sewer overflow have to be investigated; and (vi) anaerobic processes play a major role in horizontal flow constructed wetlands and should therefore be considered when modeling horizontal flow beds.

References

- Andreottola, G., E. Oliveira, P. Foladori, R. Peterlini, and G. Ziglio. 2007. Respirometric techniques for assessment of biological kinetics in constructed wetlands. *Water Sci. Technol.* 56(3):255–261.
- Bigambo, T., and A.W. Mayo. 2005. Nitrogen transformation in horizontal subsurface flow constructed wetlands: I. Effect of biofilm. *Phys. Chem. Earth* 30:668–672.
- Bornemann, C., J. Londong, M. Freund, O. Nowak, R. Otterpohl, and T. Rolfs. 1998. [A guide for the dynamic simulation of aeration plants with the IAWQ's Activated Sludge Model No. 1]. (In German.) *Korrespondenz Abwasser* 45(3):455–462.
- Brix, H. 1997. Do macrophytes play a role in constructed treatment wetlands? *Water Sci. Technol.* 35(5):11–17.
- Brix, H., and N.H. Johansen. 2004. Guidelines for vertical flow constructed wetland systems up to 30 PE. (In Danish.) *Økologisk Byfornyelse og Spildevandsrensning* No. 52. Miljøstyrelsen, Miljøministeriet, Copenhagen, Denmark.
- Chazarenc, F., G. Merlin, and Y. Gonthier. 2003. Hydrodynamics of horizontal subsurface flow constructed wetlands. *Ecol. Eng.* 21:165–173.
- Chen, S., G.T. Wang, and S.K. Xue. 1999. Modeling BOD removal in constructed wetlands with mixing cell method. *J. Environ. Eng.* 125:64–71.
- Dittmer, U., D. Meyer, and G. Langergraber. 2005. Simulation of a subsurface vertical flow constructed wetland for CSO treatment. *Water Sci. Technol.* 51(9):225–232.
- DWA-A 262. 2006. Grundsätze für Bemessung, Bau und Betrieb von Pflanzenkläranlagen mit bepflanzten Bodenfiltern zur biologischen Reinigung kommunalen Abwassers. (In German.) Deutsche Vereinigung für Wasserwirtschaft, Abwasser und Abfall e.V., Hennef, Germany.
- Freire, F.G., L.C. Davies, A. Vacas, I. Pedro, J.M. Novais, and S. Martins-Dias. 2006. Continuous and intermittent loading of a vertical flow constructed wetland for an azo dye treatment. p. 1501–1509. *In Proc. IWA Specialized Group Conf. on Wetland Systems for Water Pollution Control*, Vol. 3, 10th, Lisbon, Portugal. 23–29 Sept. 2006. Int. Water Assn., London.
- García, J., J. Chiva, P. Aguirre, E. Alvarez, J.P. Sierra, and R. Mujeriego. 2004. Hydraulic behaviour of horizontal subsurface flow constructed wetlands with different aspect ratio and granular medium size. *Ecol. Eng.* 23:177–187.
- Grosse, W., F. Wissing, R. Perfler, Z. Wu, J. Chang, and Z. Lei. 1999. Biotechnological approach to water quality improvement in tropical and subtropical areas for reuse and rehabilitation of aquatic ecosystems. Final report, INCO-DC Project Contract ERBIC18CT960059. INCO-DC, Cologne, Germany.
- Haberl, R., S. Grego, G. Langergraber, R.H. Kadlec, A.R. Cicalini, S. Martins Dias, J.M. Novais, S. Aubert, A. Gerth, H. Thomas, and A. Hebner. 2003. Constructed wetlands for the treatment of organic pollutants. *J. Soils Sediments* 3:109–124.
- Henrichs, M., G. Langergraber, and M. Uhl. 2007. Modelling of organic matter degradation in constructed wetlands for treatment of combined sewer overflow. *Sci. Total Environ.* 380:196–209.
- Henze, M., W. Gujer, T. Mino, and M.C.M. van Loosdrecht. 2000. Activated sludge models ASM1, ASM2, ASM2D and ASM3. IWA Scientific and Technical Rep. 9. Int. Water Assn., London.
- Kadlec, R.H. 2000. The inadequacy of first-order treatment kinetic models. *Ecol. Eng.* 15:105–119.
- Kadlec, R.H., and R.L. Knight. 1996. *Treatment wetlands*. CRC Press, Boca Raton, FL.
- Kadlec, R.H., R.L. Knight, J. Vymazal, H. Brix, P. Cooper, and R. Haberl (ed.). 2000. *Constructed wetlands for pollution control: Processes, performance, design, and operation*. IWA Scientific and Technical Rep. 8. Int. Water Assn., London.
- Kalyuzhnyi, S.V., and V.V. Fedorovich. 1998. Mathematical modelling of competition between sulphate reduction and methanogenesis in anaerobic reactors. *Bioresour. Technol.* 65:227–242.
- Katyal, A.K., J.J. Kaluarachchi, and J.C. Parker. 1991. MOFAT: A two-dimensional finite element program for multiphase flow and multi-component transport: Program documentation and user's guide. Center for Environ. and Hazardous Material Studies, Virginia Polytechnic Inst. and State Univ., Blacksburg.
- Kayser, K., and S. Kunst. 2005. Processes in vertical-flow reed beds: Nitrification, oxygen transfer, and soil clogging. *Water Sci. Technol.* 51(9):177–184.
- Langergraber, G. 2001. Development of a simulation tool for subsurface flow constructed wetlands. *Wiener Mitteilungen* 169, Vienna, Austria.

- Langergraber, G. 2003. Simulation of subsurface flow constructed wetlands: Results and further research needs. *Water Sci. Technol.* 48(5):157–166.
- Langergraber, G. 2005. The role of plant uptake on the removal of organic matter and nutrients in subsurface flow constructed wetlands: A simulation study. *Water Sci. Technol.* 51(9):213–223.
- Langergraber, G. 2007. Simulation of the treatment performance of outdoor subsurface flow constructed wetlands in temperate climates. *Sci. Total Environ.* 380:210–219.
- Langergraber, G., and R. Haberl. 2001. Constructed wetlands for water treatment. *Minerva Biotechnol.* 13:123–134.
- Langergraber, G., and R. Haberl. 2004. Application of constructed wetland technology in EcoSan systems. *In Proc. IWA World Water Congress, [CD-ROM], 4th, Marrakech, Morocco. 19–24 Sept. 2004. Int. Water Assn., London.*
- Langergraber, G., and J. Šimůnek. 2005. Modeling variably saturated water flow and multicomponent reactive transport in constructed wetlands. *Vadose Zone J.* 4:924–938.
- Langergraber, G., and J. Šimůnek. 2006. The multi-component reactive transport module CW2D for constructed wetlands for the HYDRUS software package. *Hydrus Software Series 2. Dep. of Environ. Sciences, Univ. of California, Riverside.*
- Langergraber, G., A. Tietz, and R. Haberl. 2007. Comparison of measured and simulated distribution of microbial biomass in subsurface vertical flow constructed wetlands. *Water Sci. Technol.* 56(3):233–240.
- Małoszewski, P., P. Wachniew, and P. Czupryński. 2006. Study of hydraulic parameters in heterogeneous gravel beds: Constructed wetland in Nowa Słupia (Poland). *J. Hydrol.* 331:630–642.
- Marsili-Libelli, S., and N. Checchi. 2005. Identification of dynamic models for horizontal subsurface constructed wetlands. *Ecol. Modell.* 187:201–218.
- Mashauri, D.A., and S. Kayombo. 2002. Application of the two coupled models for water quality management: Facultative pond cum constructed wetland models. *Phys. Chem. Earth* 27:773–781.
- Mayo, A.W., and T. Bigambo. 2005. Nitrogen transformation in horizontal subsurface flow constructed wetlands: I. Model development. *Phys. Chem. Earth* 30:658–667.
- Mayo, A.W., and J. Mutamba. 2005. Modelling nitrogen removal in a coupled HRP and unplanted horizontal flow subsurface gravel bed constructed wetland. *Phys. Chem. Earth* 30:673–679.
- McGechan, M.B., S.E. Moir, K. Castle, and I.P.J. Smit. 2005a. Modelling oxygen transport in a reedbed-constructed wetland purification system for dilute effluents. *Biosystems Eng.* 91:191–200.
- McGechan, M.B., S.E. Moir, G. Sym, and K. Castle. 2005b. Estimating inorganic and organic nitrogen transformation rates in a model of a constructed wetland purification system for dilute farm effluents. *Biosystems Eng.* 91:61–75.
- Meyer, D., G. Langergraber, and U. Dittmer. 2006. Simulation of sorption processes in subsurface vertical flow constructed wetlands for CSO treatment. p. 599–609. *In Proc. IWA Specialized Group Conf. on Wetland Systems for Water Pollution Control, Vol. 1, 10th, Lisbon, Portugal. 23–29 Sept. 2006. Int. Water Assn., London.*
- Molle, P., A. Liénard, C. Boutin, G. Merlin, and A. Iwema. 2005. How to treat raw sewage with constructed wetlands: An overview of the French systems. *Water Sci. Technol.* 51(9):11–21.
- Ojeda, E., J. Caldentej, and J. García. 2006. 2D simulation model for evaluating biogeochemical pathways involved in organic matter removal in horizontal subsurface flow constructed wetlands. p. 1405–1413. *In Proc. IWA Specialized Group Conf. on Wetland Systems for Water Pollution Control, Vol. 3, 10th, Lisbon, Portugal. 23–29 Sept. 2006. Int. Water Assn., London.*
- ÖNORM B 2505. 2005. [Subsurface-flow constructed wetlands: Application, dimensioning, installation, and operation]. (In German.) Österreichisches Normungsinstitut, Vienna, Austria.
- Pastor, R., C. Benqilou, D. Paz, G. Cardenas, A. Espuña, and L. Puigjaner. 2003. Design optimisation of constructed wetlands for wastewater treatment. *Resour. Conserv. Recycling* 37:193–204.
- Perfler, R., J. Laber, G. Langergraber, and R. Haberl. 1999. Constructed wetlands for rehabilitation and reuse of surface waters in tropical and subtropical areas: First results from small-scale plots using vertical flow beds. *Water Sci. Technol.* 40(3):155–162.
- Rezaei, M., E. Sanz, E. Raesi, C. Ayora, E. Vázquez-Suñé, and J. Carrera. 2005. Reactive transport modeling of calcite dissolution in the fresh-salt water mixing zone. *J. Hydrol.* 311:282–298.
- Rousseau, D.P.L. 2005. Performance of constructed treatment wetlands: Model-based evaluation and impact of operation and maintenance. Ph.D. diss., Ghent Univ., Belgium.
- Rousseau, D.P.L., P.A. Vanrolleghem, and N. De Pauw. 2004. Model-based design of horizontal subsurface flow constructed treatment wetlands: A review. *Water Res.* 38:1484–1493.
- Saaltink, M.W., C. Ayora, P.J. Stuyfzand, and H. Timmer. 2003. Analysis of a deep well recharge experiment by calibrating a reactive transport model with field data. *J. Contam. Hydrol.* 65:1–18.
- Schwager, A., and M. Boller. 1997. Transport phenomena in intermittent filters. *Water Sci. Technol.* 35(6):13–20.
- Šimůnek, J., M. Šejna, and M.Th. van Genuchten. 1998. The HYDRUS-1D software package for simulating the one-dimensional movement of water, heat, and multiple solutes in variably-saturated media. Version 2.0. U.S. Salinity Lab., USDA-ARS, Riverside, CA.
- Šimůnek, J., M. Šejna, and M.Th. van Genuchten. 2006a. The HYDRUS software package for simulating the two- and three-dimensional movement of water, heat, and multiple solutes in variably-saturated media: Technical manual. Version 1.0. PC-Progress, Prague, Czech Republic.
- Šimůnek, J., M. Šejna, and M.Th. van Genuchten. 2006b. The HYDRUS software package for simulating the two- and three-dimensional movement of water, heat, and multiple solutes in variably-saturated media: User manual. Version 1.0. PC-Progress, Prague, Czech Republic.
- Stein, O.R., J.A. Biederman, P.B. Hook, and W.C. Allen. 2006. Plant species and temperature effects on the k-C* first-order model for COD removal in batch-loaded SSF wetlands. *Ecol. Eng.* 26:100–112.
- Tanner, C.C. 2001. Plants as ecosystem engineers in subsurface-flow treatment wetlands. *Water Sci. Technol.* 44(11–12):9–17.
- Tietz, A., G. Langergraber, K. Sleytr, A. Kirschner, and R. Haberl. 2007. Characterization of microbial biocoenosis in vertical subsurface flow constructed wetlands. *Sci. Total Environ.* 380:163–172.
- Tomenko, V., S. Ahmed, and V. Popov. 2007. Modelling constructed wetland treatment system performance. *Ecol. Modell.* 205:355–364.
- Toscano, A., G. Langergraber, and G.L. Cirelli. 2006. Simulation of hydraulics and pollutant removal of a pilot-scale two-stage constructed wetlands functioning as secondary or tertiary treatment. p. 1303–1311. *In Proc. IWA Specialized Group Conf. on Wetland Systems for Water Pollution Control, Vol. 2, 10th, Lisbon, Portugal. 23–29 Sept. 2006. Int. Water Assn., London.*
- Van Cappellen, P., and J.-F. Gaillard. 1996. Biogeochemical dynamics in aquatic sediments. p. 335–376. *In P.C. Lichtner, C.I. Steefel, and E.H. Oelkers (ed.) Reviews in mineralogy and geochemistry. Vol. 34. Mineralogical Soc. of America, Washington, DC.*
- van Genuchten, M.Th. 1980. A closed-form equation for predicting the hydraulic conductivity of unsaturated soils. *Soil Sci. Soc. Am. J.* 44:892–898.
- Vymazal, J., H. Brix, P.F. Cooper, M.B. Green, and R. Haberl (ed.). 1998. Constructed wetlands for wastewater treatment in Europe. Backhuys, Leiden, The Netherlands.
- Wanko, A., N. Forquet, R. Mose, and A.G. Sadowski. 2006a. Oxygen transfer rates estimation for sand bed design: Model calibration and validation. p. 1595. *In Proc. IWA Specialized Group Conf. on Wetland Systems for Water Pollution Control, Vol. 3, 10th, Lisbon, Portugal. 23–29 Sept. 2006. Int. Water Assn., London.*
- Wanko, A., R. Mose, J. Carrayrou, and A.G. Sadowski. 2006b. Simulation of biodegradation in infiltration seepage: Model development and hydrodynamic calibration. *Water Air Soil Pollut.* 177:19–43.
- Werner, T.M., and R.H. Kadlec. 2000. Wetland residence time modeling. *Ecol. Eng.* 15:77–90.
- Wynn, M.T., and S.K. Liehr. 2001. Development of a constructed subsurface-flow wetland simulation model. *Ecol. Eng.* 16:519–536.